

· CRT Alignment Tools ·

© 1992 By Time/Slice Systems & S. Jenkins
All Rights Reserved

Help!

Table of Contents:

Using CRT Alignment Tools



Keyboard



Mouse

Tools:

SETUP

TEST



Color Purity



Resolution



Static Convergence



Readability



Dynamic Convergence



Color Bars



Aspect Ratio



White Balance

Appendices:

A: Application Information

B: Color CRT - Theory of Operation

C: Glossary

D: Legal Issues

E: Technical Support

Notes:

1) This help document applies to electron guns in a **delta**(triangular) arrangement. There are two other common arrangements: the **in-line**, where the electron guns are in a line, and **Trinitron**, where a single electron gun is used to produce all three electron beams. Although this application applies to electron guns in a delta configuration, many of the setups and test screens can be used for evaluating other types of displays.

2) Most of the adjustments for aligning a CRT are specific to a particular make and model, so in order to align any given CRT properly, you should get a setup manual from the monitor manufacturer.

3) Throughout this help document you will see the eye icon(). This indicates that there is a graphic associated with this item. To view the graphic: with the keyboard, tab to the eye icon and press the [ENTER] key; with a mouse, click on the eye icon.

is copyrighted by Time/Slice Systems © 1992.

Appendix A:

Application Information:

CRT·A·T is a Windows 3.xx application. It consists of five Setup and three Test screens that can be used to align and evaluate CRT(video)  monitors in the Windows GUI environment. It was written in Visual Basic.

Requirements:

Windows 3.xx in VGA(640x480) or higher resolution with the standard system font.
VBRUN100.DLL(Visual Basic 1.00 runtime dynamic link library).

Included Files:

CRTAT.EXE(application).
CRTAT.HLP(help file).

Version History:

Ver. 1.00 - February 9, 1992

**This help document(all text, graphics and hyperlinks)
is copyrighted by Time/Slice Systems © 1992.**

Appendix B:

Color CRT Operation:

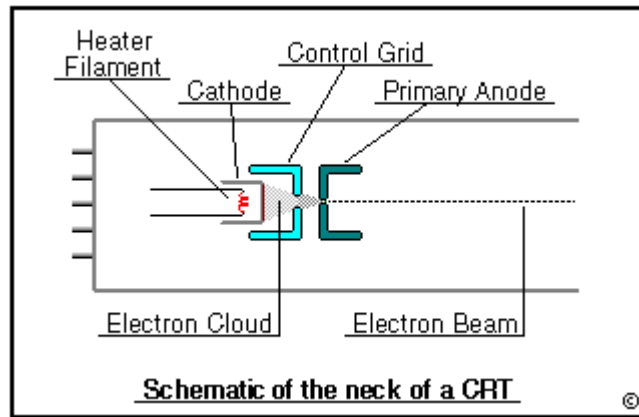

In the neck of the CRT, a small voltage is applied to the heater filament; as the filament glows, it heats up the cathode. The cathode is coated with a material that freely gives off electrons when heated. The electrons are attracted to the screen by voltages applied to the primary and secondary anodes. The primary anode usually has a voltage potential of a few hundred volts. This gives the electron beams their first pull in the right direction (towards the screen). As the beams move into the bell (wide) area of the CRT, the secondary anode (at several thousands of volts) keeps the beams headed toward the screen. The focus of the beams can be controlled by changing the voltage of one of the anodes.

As these streams of electrons begin their path to the screen they first pass through the control grid. This grid can be used to control the number of electrons that reach the screen and thereby adjust the picture brightness (note: brightness can be controlled in other ways).

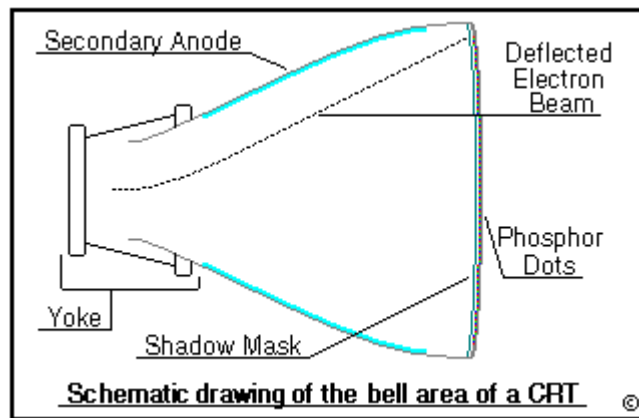

The next control area the beams pass through is the yoke  area, where the beams are deflected left and right, and down and up, by the deflection coils. These coils carry pulsed voltages synchronized to the horizontal and vertical sweep rates. The voltages in the coils create magnetic fields that cause the electron beams to deflect away from their usual straight path. The voltages are applied to the coils so that the electron beams scan from left to right then snap back to the left and move down one pixel. This scanning process continues until the bottom right of the image, when the beams are repositioned at the top left, ready to scan the next frame.

The final control area the electron beams pass through is the shadow mask. The shadow

mask is a metal sheet stretched directly behind the phosphor coating on the front interior of the CRT. This metal sheet has holes in it that allow the three electron beams to only hit their respective color phosphor dots. One hole in the shadow mask represents one triad (one red, one green and one blue phosphor dot) on the screen.

Finally the electrons bombard the phosphor dots. This causes the phosphor dots to emit their respective colored light.

**This help document(all text, graphics and hyperlinks)
is copyrighted by Time/Slice Systems © 1992.**

Using CRT·A·T(CRT Alignment Tools):

CRT·A·T CONTROL PANEL AREAS:

The Title Bar:

The bar across the top of CRT·A·T Control Panel that contains the control menu icon, the title bar and the minimize icon.

The Tool Palette:

The palette, consisting of eight tools, is divided into two(Setup and Test) sections. The active tool is highlighted with a florescent blue frame, and the name of the tool appears in the tools caption area. Normally you would use the Setup tools in the order that they are on the palette.

The Mode Window:

This window contains various florescent indicators that provide a way to change the mode of the current tool. See help on the specific tool(Shift+F1) for more information.

Exiting CRT·A·T:

You can exit CRT·A·T in a couple of different ways:

Classic(cool)	Fast
----------------------	-------------



Alt+P

Alt+F4



click on Power buttondouble click on the
control menu icon

See also:  Keyboard
 Mouse



CRT·A·T Keyboard interface:

When CRT·A·T Control Panel is visible:

F1	CRT·A·T Help table of contents.
Shift+F1	About the currently selected tool.
Alt+F4	Exit(end CRT·A·T).
Tab	Move to the next selectable object.
Shift+Tab	Move to the previous selectable object.
Arrow keys	Move and select within active group of objects.
1 thru 8	Select a tool from the <u>Tool Palette</u> .
Spacebar	Turn on or off an active check box or choose the active command button.
Alt+Underlined letter	Select and choose the object with that underlined letter.
Enter	Choose active command button.
Esc	Hide the CRT·A·T Control Panel.
Alt or F10	Activate the <u>Control Menu Icon</u> .

When Control Menu Icon is active:

Spacebar	Display Control Panel Control Menu.
Esc or Alt or F10	Cancel menu.

When Control Menu is displayed:

Down Arrow	Highlight next command.
Up Arrow	Highlight previous command.
Underlined letter	Choose command that contains that underlined letter.
Enter	Choose highlighted command.
Esc	Cancel the menu.

When CRT·A·T Control Panel is hidden:

F1	CRT·A·T Help table of contents.
Shift+F1	About the currently selected tool.
Alt+F4	Exit(end CRT·A·T).
1 thru 8	Select a tool from the <u>Tool Palette</u> .
Spacebar	Display the CRT·A·T Control Panel.
Esc	Iconize CRT·A·T.

When CRT·A·T is an icon:

Alt+Spacebar	Display CRT·A·T Control Panel Control Menu.
--------------	---

Keys for switching between other Windows applications:

Alt+Esc	Switch to next application.
Alt+Shift+Esc	Switch to previous application.
Alt+Tab	Switch to next application(restore window).
Alt+Shift+Tab	Switch to previous application(restore window).
Ctrl+Esc	Display the Windows Task List.



CRT·A·T Mouse interface:

When CRT·A·T Control Panel is visible:

- Click on minimize icon Iconize CRT·A·T.
- Drag the title bar Move CRT·A·T Control Panel.
- Left click Select and choose the object the cursor is over.
- Right click Hide the CRT·A·T Control Panel(not available when
the cursor is over certain objects - move your mouse
and try again).

When CRT·A·T Control Panel is hidden:

- Left click Displays the CRT·A·T Control Panel.
- Right click Iconize CRT·A·T.

When CRT·A·T is an icon:

- Left click Display CRT·A·T Control Panel Control Menu.
- Left double click Restore CRT·A·T to full screen.

**This help document(all text, graphics and hyperlinks)
is copyrighted by Time/Slice Systems © 1992.**



Color Purity Tool:

The purity of a color picture tube refers to the fact that electrons emitted from the red, green and blue electron guns should strike only their respective color phosphor  dots. If the tube is not "pure" you will notice areas of secondary colors on the otherwise smooth wash of primary color. The cause of these secondary colors is the electrons from one gun are illuminating the phosphor

 dots of one or both other colors or partially missing their respective colored dot.



Mode: If the **red** gun is not "pure" you will notice areas of either dull red, brownish-yellow or magenta. If the **green** gun is not "pure" you will notice areas of either dull green, brownish-yellow or cyan. If the **blue** gun is not pure you will notice areas of either dull blue, cyan or magenta.

Adjustments: You should have fairly good static convergence before adjusting the color purity. Purity is usually set by moving the yoke  and purity rings.

Note: Color impurities can also be caused by stray magnetic fields which can cause the electron beams to diverge from their paths. These fields can be caused by magnetism accumulating within the CRT. To get rid of this magnetic buildup you must degauss the monitor.



Static Convergence Tool:

Static convergence is the alignment of the three (red, green, blue) electron beams in the central area of the screen, where the deflection yoke  has minimal influence. When a monitor has good static convergence the dots in the central area of the screen should appear as pure white dots, with no color fringes. If there is color fringing, this means that the three beams are not converging on the same color triad  and the monitor needs to be statically converged.



Mode: The three choices (**high**, **medium** and **low**) provide various test patterns, differing in complexity.

Adjustments: Static convergence is usually set by convergence magnets that are mounted on the yoke  assembly on the neck of the picture tube.

**This help document (all text, graphics and hyperlinks)
is copyrighted by Time/Slice Systems © 1992.**



Dynamic Convergence Tool:

Dynamic convergence is the alignment of the three (red, green, blue) electron beams in the peripheral area of the screen, where the deflection yoke  has its maximum influence. When a monitor has good dynamic convergence the lines in the peripheral area of the screen should appear as pure white lines, with no color fringing. If there is color fringing, this means that the three beams are not converging on the same color triad  and the monitor needs to be dynamically converged.

Mode: The three choices (**high**, **medium** and **low**) provide various test patterns, differing in complexity.

Adjustments: Dynamic convergence is adjusted with various internal potentiometers that vary the voltages to the deflection coils in the yoke  assembly.

**This help document (all text, graphics and hyperlinks)
is copyrighted by Time/Slice Systems © 1992.**



Aspect Ratio Tool:

These three screens provide a tool for making sure the full screen image is producing the correct height to width ratio(3:4). To determine if your image area is in the correct ratio, measure either the width and multiply by .75 to get the proportional height, or the height and multiply by 1.333 to get the proportional width. Another item to check is the linearity of the image, the width of the image should be constant from top to bottom and the height should be constant from side to side, and the squares should be square. The circles provide another way to evaluate aspect ratio; circles should be round!

Mode: The three choices(**high**, **medium** and **low**) provide various test patterns, differing in complexity.

Adjustments: The aspect ratio is adjusted with various potentiometers. Usually the vertical(height) and horizontal(width) controls are the only ones adjustable without removing the monitor cover. If you have a non-linearity problem, the potentiometers will probably be internal, mounted on circuit boards.

This help document(all text, graphics and hyperlinks)
is copyrighted by Time/Slice Systems © 1992.



White Balance Tool:

The white setup screen provides a tool for making sure the full screen is producing a good clean white when the screen is fully illuminated. Also check the lower levels of illumination to see if there is any color crossover from light to dark. You should also adjust the monitors contrast and brightness controls through their full ranges to determine if there is any crossover.

Mode: The three modes(**white**, **2/3** and **1/3**) provide various levels of illumination.

Adjustments: The white balance is adjusted with three potentiometers(usually within the monitor), that vary the absolute voltage to the three color guns. The procedure is along the lines of: turn all the color guns to minimum, then bring up the red gun until the screen is a bright red wash. Next bring up the green gun level until you have a bright yellow wash. Last adjust the blue gun so that you get a good bright white.

This help document(all text, graphics and hyperlinks)
is copyrighted by Time/Slice Systems © 1992.



Resolution Tool:

This tool is useful for checking whether the CRT is capable of displaying finely spaced lines across the entire CRT image area. Both horizontal and vertical resolution can be checked.

Mode: The **horizontal/vertical** check box controls whether you are testing horizontal or vertical resolution. The **1 pixel/2 pixel** check box controls the line and spacing width.

Note: Setting the mode to horizontal at 1 pixel(both check boxes on) is an extreme test for CRTs running in high(600x800 +) resolution modes(especially 16" or smaller monitors). Because of the way the electron beams scan the CRT screen, the beams must turn completely on and then completely off within the span of 1 pixel. This stresses both the electronics of the video adapter card and the monitor. If you can't see the individual white lines you might see a gray screen or you might see interference patterns, both indicating the dot pitch is probably too coarse for this resolution/image-size combination. The solution to this kind of problem is to either run your monitor at a lower resolution, or get a monitor with a larger image area.

**This help document(all text, graphics and hyperlinks)
is copyrighted by Time/Slice Systems © 1992.**



Readability Tool:

Use this tool to check whether text is readable across the entire CRT image area. The type is based on one pixel lines. The separation between lines of type is also one pixel. The text should be readable, either normal or inverted, and all parts of each letter should be clear. If there are alignment problems you might notice color fringing or bad focus; in any case the text will not appear sharp, possibly even unreadable.

Mode: The **invert** check box controls whether the text is black on white or white on black.

Note: If you have high resolution video on a small screen monitor it will be extremely difficult to get readable text because the alignment tolerances are too tight.

See: [Resolution](#)

This help document(all text, graphics and hyperlinks)
is copyrighted by Time/Slice Systems © 1992.



Color Bars Tool:

This tool is a variation on the color purity tool. To use it you should run it through all the settings and observe whether there is any color impurity. You should also check that the line of transition from one color to another is sharp and there isn't any color fringing or smearing. Especially check the secondary(cyan, magenta, yellow) color bars for this problem, since these colors require two of the primary(red, green, blue) colors to be on at once.

Mode: The **vertical/horizontal** check box controls whether the color bars are horizontal or vertical. The **separation bars** check box controls whether there are separation bars between the color bars. The **black/white** check box controls whether the separation bars between the color bars are black or white.

See: [Color Purity](#)

This help document(all text, graphics and hyperlinks)
is copyrighted by Time/Slice Systems © 1992.

Appendix D:

Legal Issues:

· CRT Alignment Tools ·

© 1992 by Time/Slice Systems
& Steve Jenkins
All rights reserved.

This application is Freeware.

This application is copyrighted and is **NOT** in the public domain.

You are free to use, and make copies of, this application as long as no fee is charged.

DISCLAIMER: You use this application at your own discretion. I am not liable for any damages that may result from the use of this application. No warranties, expressed or implied, exist.

ACKNOWLEDGMENTS: Once again, many thanks to Dave Lobb as chief beta tester and critic. Profound appreciation to Microsoft for releasing Visual Basic, and thereby opening up Windows applications development to the masses.

Windows is a trademark of Microsoft.

Visual Basic is a trademark of Microsoft.

VBRUN100.DLL is copyright by Microsoft.

Microsoft is a registered trademark of Microsoft Corporation.

CompuServe is a registered trademark of CompuServe Information Services.

Trinitron is a registered trademark of Sony Corporation.

This help document(all text, graphics and hyperlinks)
is copyrighted by Time/Slice Systems © 1992.

Appendix E:

Technical Support:

If you have any trouble with, or suggestions for, CRT·A·T, you can contact the author through CompuServe using ID# **76666,1066**, or write to:

Steve Jenkins
1310 S. Taylor St. #22
Arlington, VA 22204-3718

This help document(all text, graphics and hyperlinks)
is copyrighted by Time/Slice Systems © 1992.

Appendix C:

Glossary:

Crossover

CRT(Cathode-Ray Tube)

Degauss

Linearity 

Mode Panel

Phosphor

Setup

Test

Title Bar

Tool Palette

Triad 

Yoke 

**This help document(all text, graphics and hyperlinks)
is copyrighted by Time/Slice Systems © 1992.**

Cathode-Ray Tube. Any vacuum tube that emits electrons from its cathode. See CRT Theory of Operation(elsewhere in this help document) for a complete description.

Degauss. The act of neutralizing accumulated extraneous magnetism from an object. Usually done by bringing an alternating magnetic field close to the object. Many newer monitors have built-in degaussing coils that are activated by turning the monitor power either on or off.

Phosphor. The coating on the interior of the CRT screen that converts the electron energy into light. Different phosphors produce different colors. To produce a visual white with three phosphors (red, green and blue) requires a great deal of precision.

Triad. A tight cluster of three phosphor dots consisting of one red, one green, and one blue dot. When all three of the dots are evenly illuminated, your eye perceives it as white. If you use a magnifying glass you can see the triads. A pixel usually consists of several triads.

Yoke. The donut shaped assembly that mounts around the neck of a picture tube(CRT). It contains the deflection coils and various alignment magnets and coils.

Linearity. Lines should be straight and parallel. They should not bow in or out, or diverge.

Crossover. When the color of the image varies depending on the brightness level. A very common crossover that occurs in photography is having green shadows and magenta highlights.

Setup. These five screens provide tools used to make sure that a video display tube's magnets and electronics are all in alignment. Generally the controls for these adjustments are inside the monitor housing, close to the yoke.

Test. These three screens allow you to evaluate the performance of a video display. Generally they are not used to align the monitor, but rather to see if the monitor is performing up to its specifications.

I repeat, **NOT** . . .



© 1992

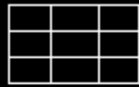

Good linearity



Barrel

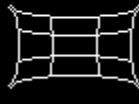

Pin-Cushion

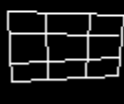

Non-parallel

Types of non-linear distortion

©

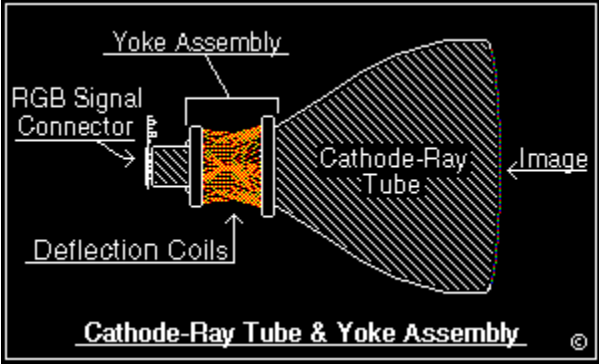





Mode:	<input checked="" type="checkbox"/> Vertical/Horizontal
<input type="checkbox"/> shift	<input checked="" type="checkbox"/> Separator bars
	<input checked="" type="checkbox"/> Black/White

